

#### Features

- 18" (457 mm) minimum base cabinet width
- Single bowl
- 9-1/2" (241 mm) depth provides generous workspace
- Includes sink rack
- Includes cutout templates and installation clips
- Matte finish offers rich, dimensional color

#### Material

- KOHLER Neoroc® composite is durable and built to withstand day-to-day cleaning tasks
- Solid color throughout the sink
- Heat-resistant up to 750°F
- Scratch-, stain-, chip-, and thermal-shock-resistant

#### Installation

- Undermount
- Easy to install in a one-person, single-day project

#### Recommended Products/Accessories

- K-8801 Sink drain and strainer with tailpiece
- K-8799 Sink drain and strainer basket
- K-23726 Drain treatment
- K-23730 Neoroc® cleaner

#### Optional Products/Accessories

- K-11352 Disposal Flange with Stopper
- K-9000 P-Trap

#### Included Components

- 1193643 Basin clamps
- K-5658 Stainless steel sink rack



ADA

#### Codes/Standards







CSA B45.5/IAPMO Z124  
ADA  
ICC/ANSI A117.1

#### KOHLER® Neoroc® Sinks Lifetime Limited Warranty

See website for detailed warranty information.

#### Available Colors/Finishes

*Color tiles intended for reference only.*

Color	Code	Description
	CM6	Matte White
	CM7	Matte Graphite
	CM1	Matte Black
	CM2	Matte Brown
	CM3	Matte Taupe
	CM4	Matte Grey

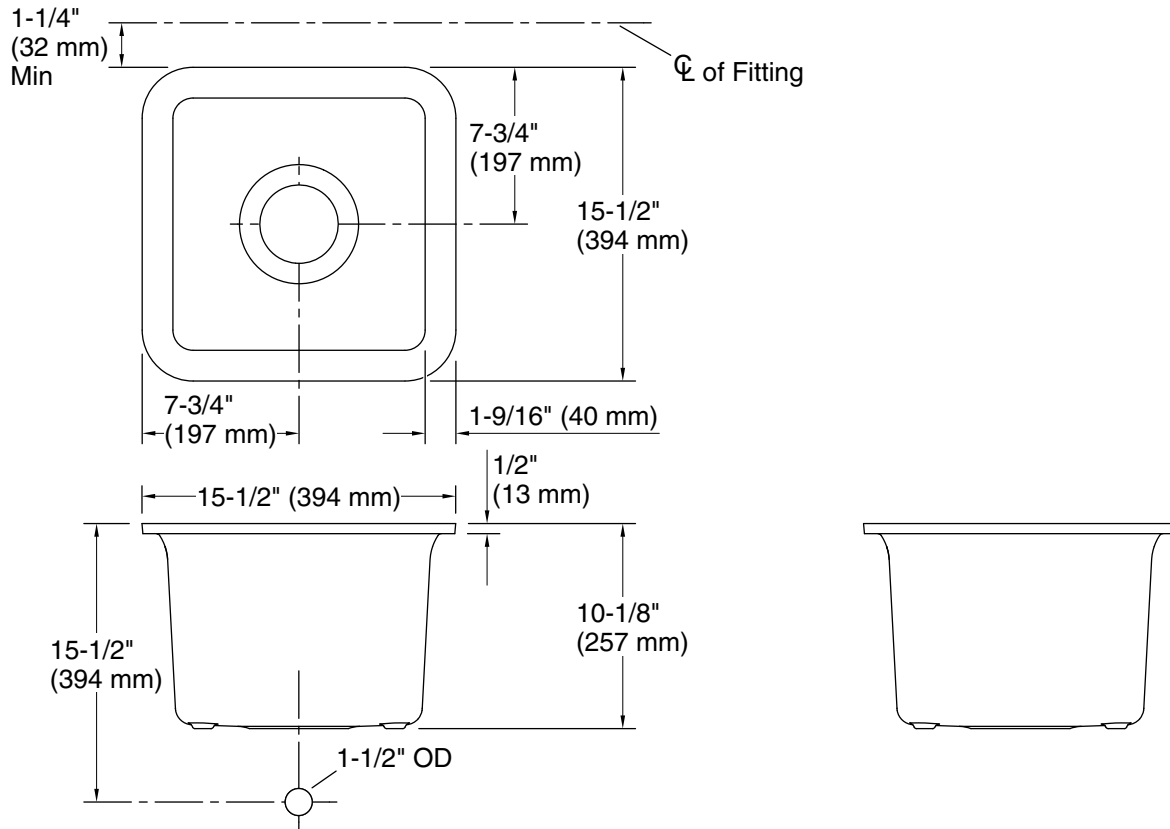

## Technical Information

All product dimensions are nominal.

Basin configuration: Single Bowl  
 Min. base cabinet width: 18" (457 mm)

Bowl area: Length: 13-9/16" (344 mm)  
 Width: 13-9/16" (344 mm)  
 Bowl depth: 9-1/2" (241 mm)  
 Water depth: 9-1/2" (241 mm)

Drain hole: 3-7/8" (99 mm)

Template: 1257826-7, required, included

## Notes

Install this product according to the installation instructions.

ADA compliant when installed to the specific requirements of these regulations.

ADA permits a parallel approach to wet bars.